

Congress Hall

PVA
EXPO PRAGUE

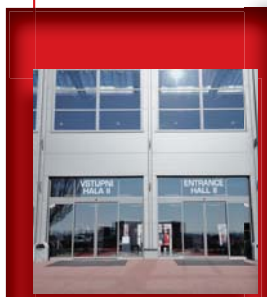

Congress Hall



- Part of PVA EXPO PRAGUE, the largest exhibition centre in Prague, Czech Republic
- Situated in the Czech capital, a major Central-European financial and business hub
- The opening ceremony took place in March 2015
- Placed in Entrance Hall II of PVA EXPO PRAGUE, between halls 3 and 4
- Adjacent to a car park with 3,000 parking spots
- Seats up to 650 people
- Ideal for hosting congresses, conferences, training, parties, corporate events or lectures
- A spacious foyer where additional programme can take place - an open bar, banquet, reception, etc.
- Wheelchair accessible
- The space can be arranged into various layouts

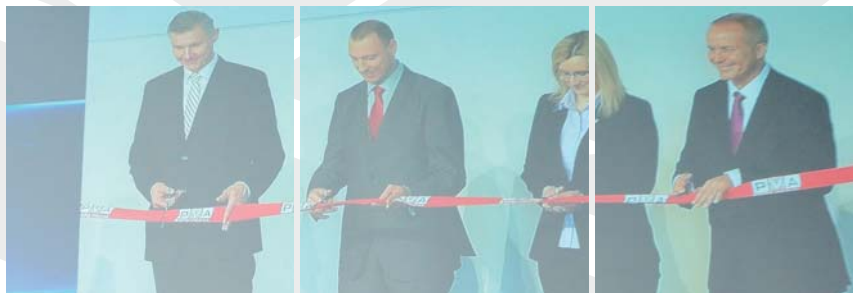

ground floor

Entrance Hall II

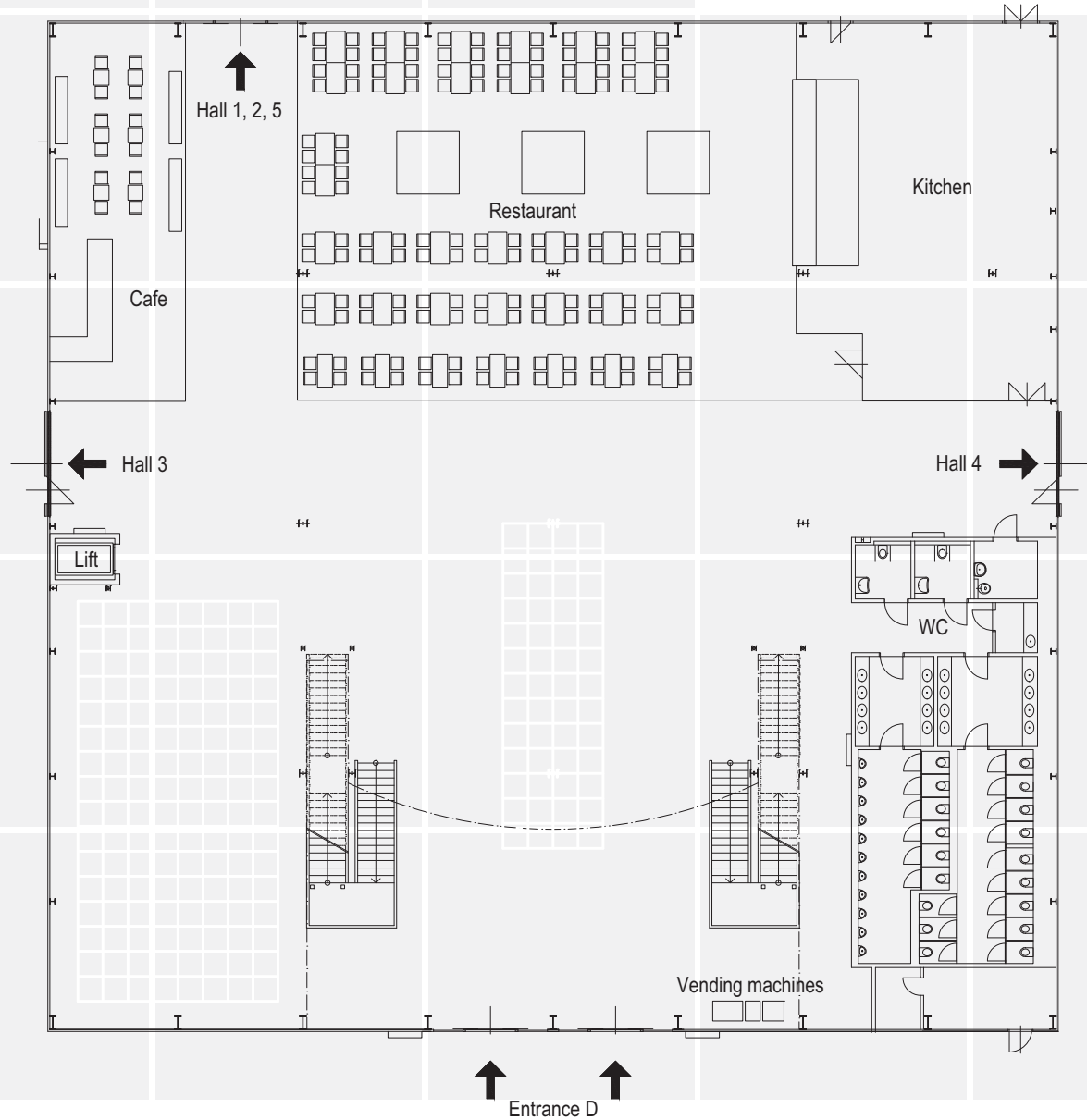

1st floor

Entrance Hall II

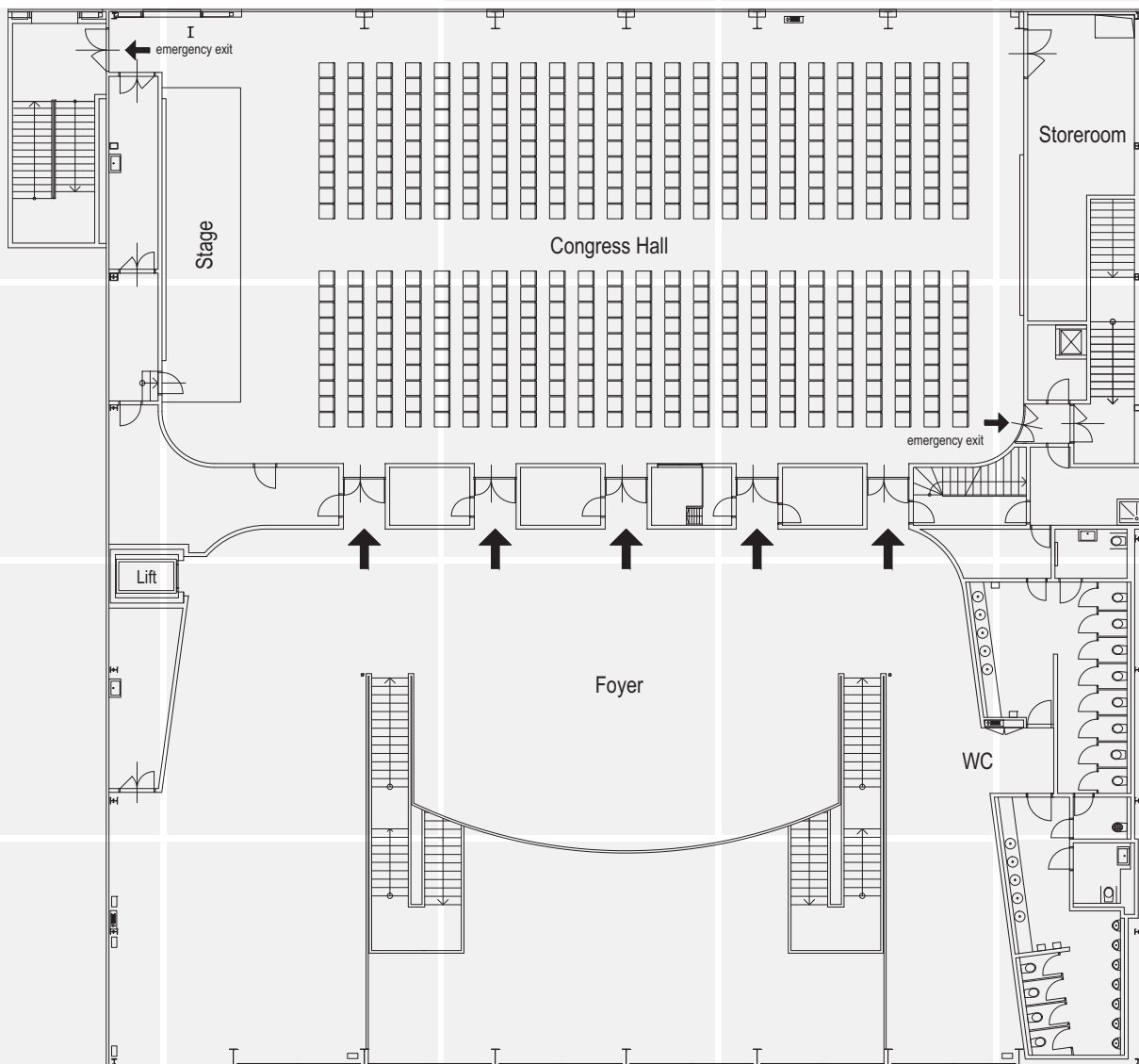

the „theatre“ layout

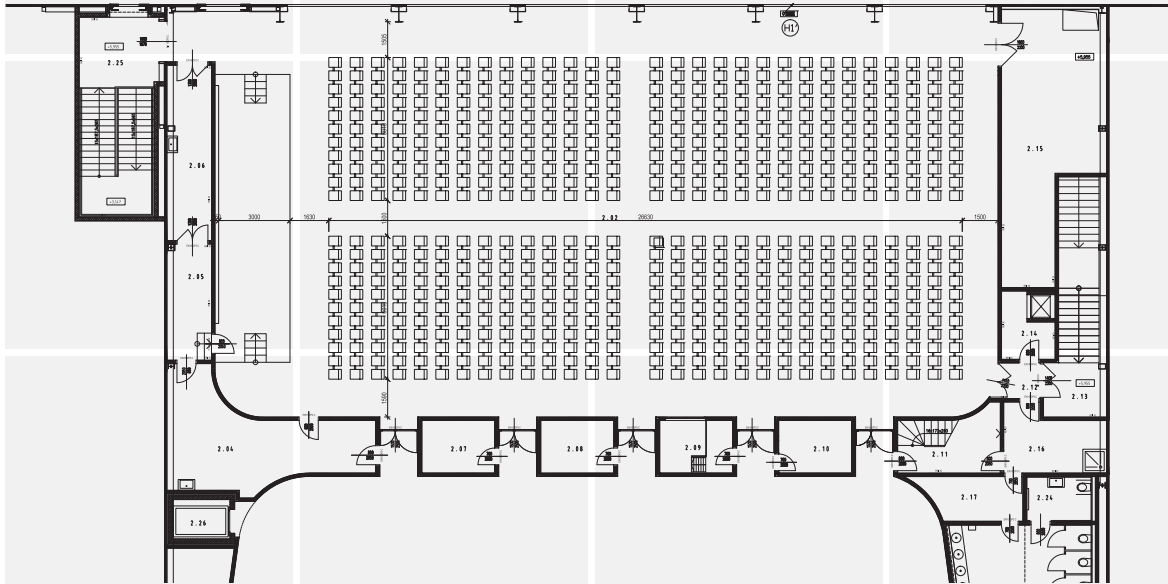

deep layout
seating capacity:
650

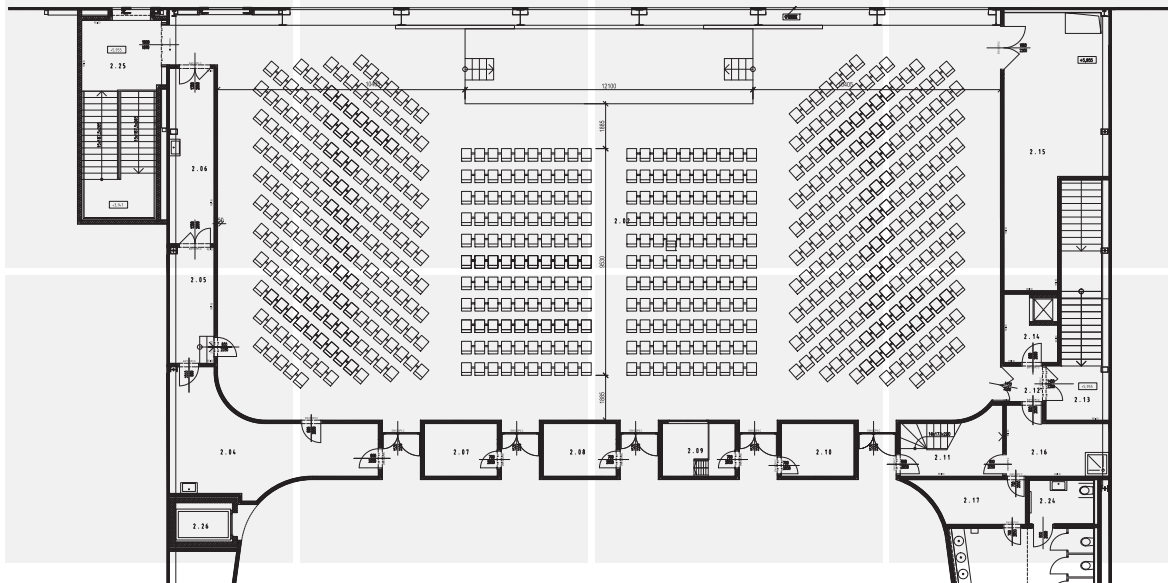

wide layout
seating capacity:
580



...when
you enter...

the „classroom“ layout

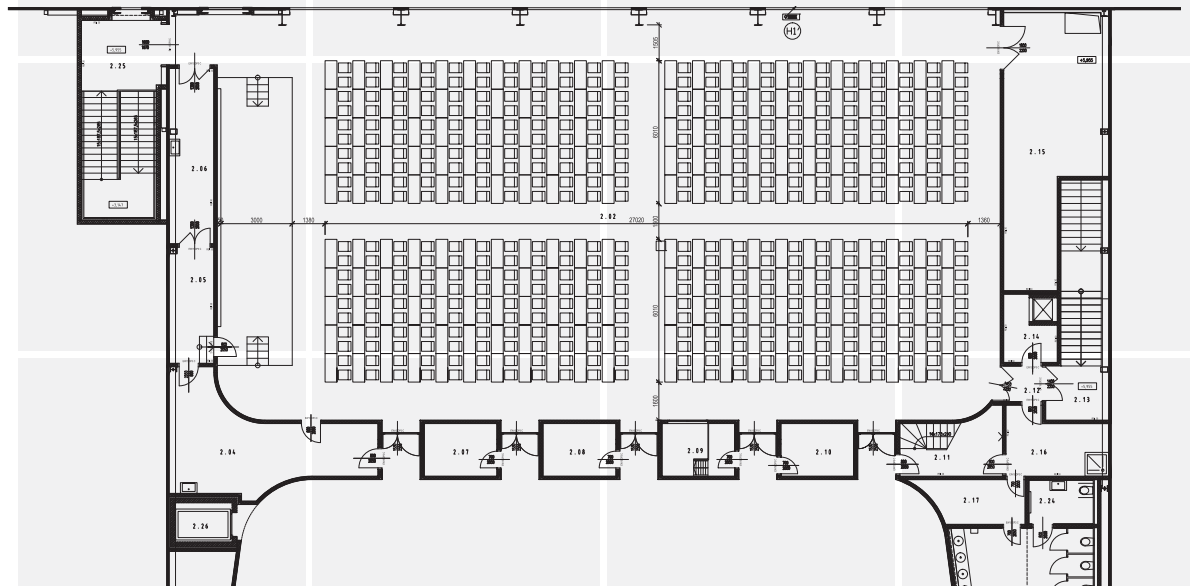

deep layout

seating capacity:
420

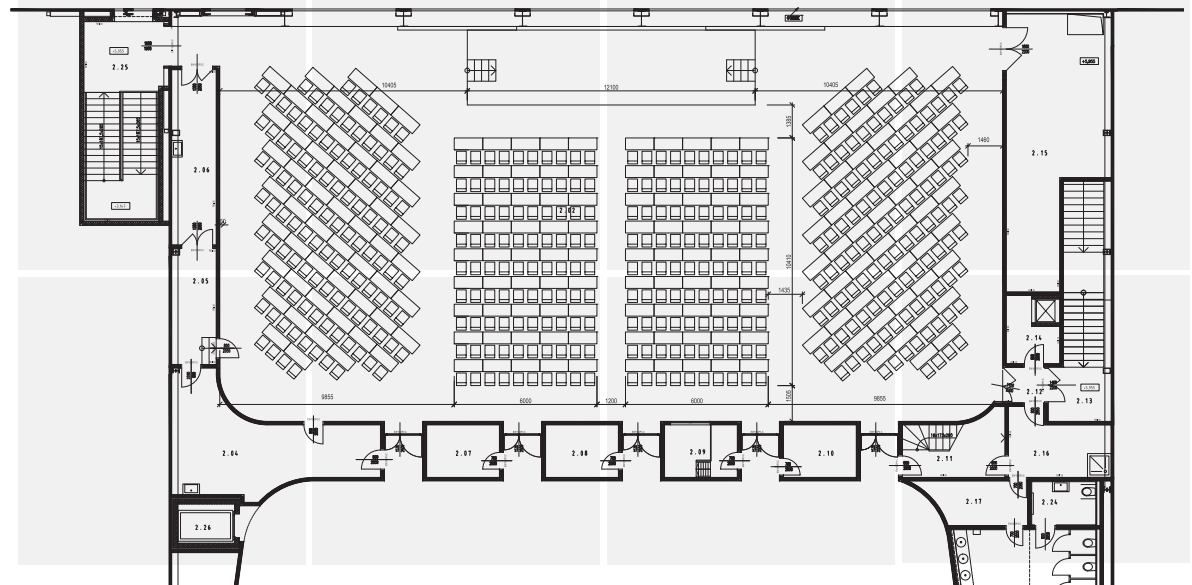

wide layout

seating capacity:
400

the „banquet“ layout

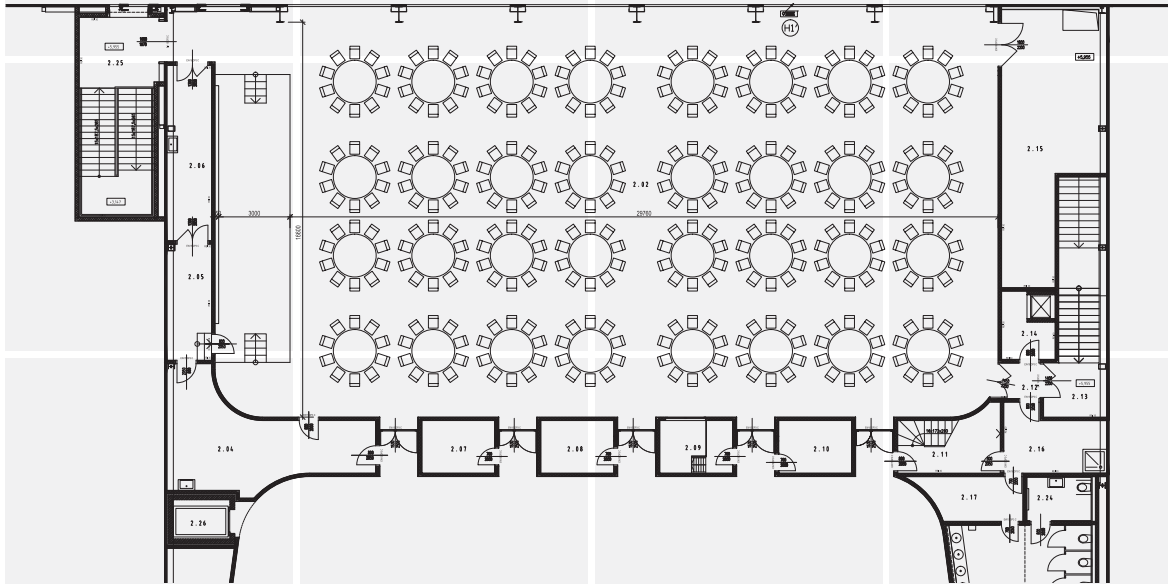

deep layout
seating capacity:
320

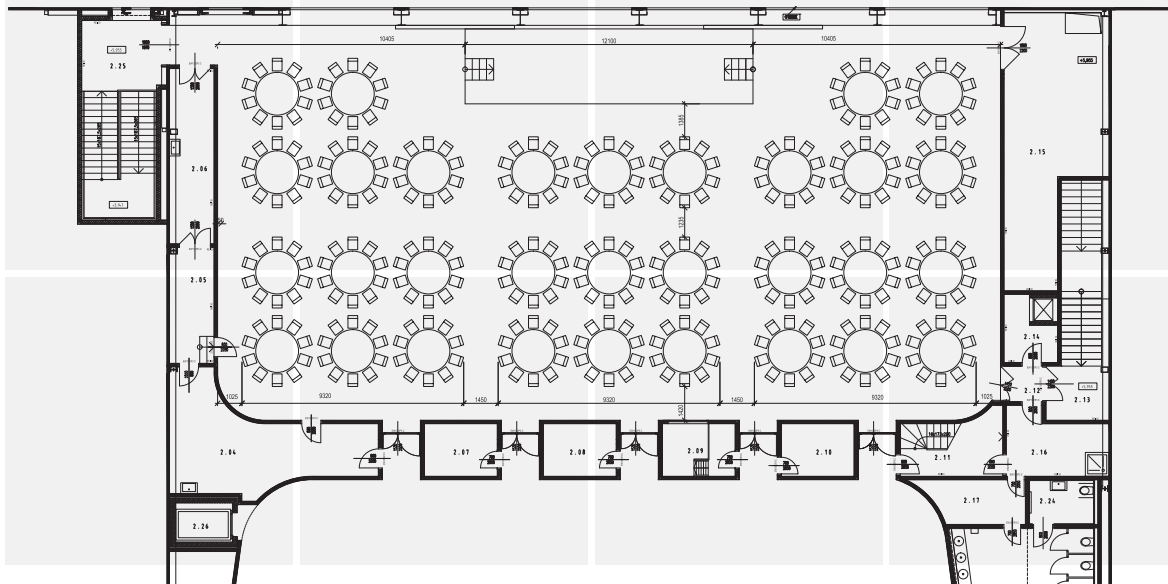

wide layout
seating capacity:
310

the „catwalk“ layout

deep layout
seating capacity:
530

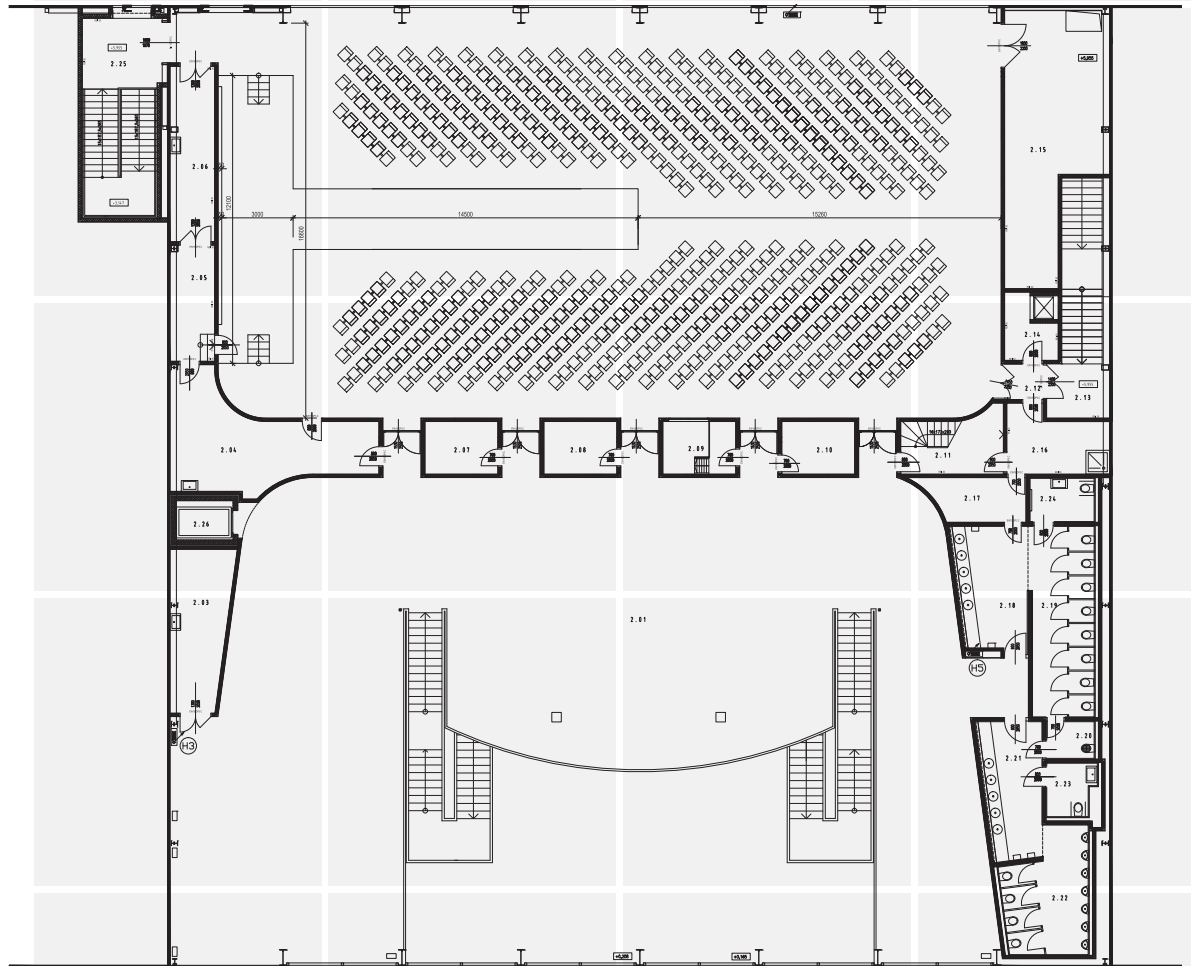

facilities and equipment

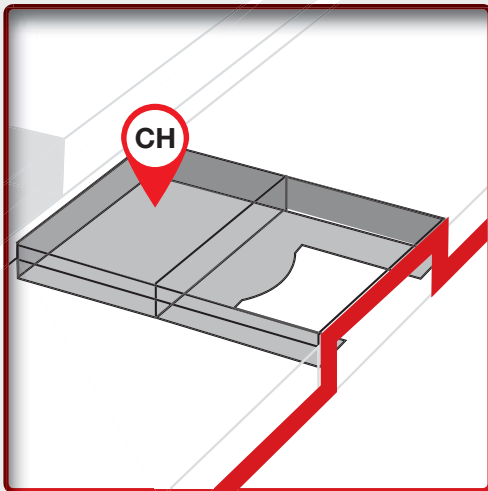

CH Congress Hall
1st floor of ENTRANCE HALL II

- State-of-the-art AV technologies with AMX control systems
- Operation of projection, AV and lighting systems is user-friendly and intuitive
- Shading systems, air-conditioned
- Wide HD screen
- Movable stage - can be placed both horizontally and vertically
- Lounge for VIP guests
- Backstage for catering and event organizers



Venue address:
PVA EXPO PRAGUE
Beranových 667, 199 00 Praha 18, Czech Republic
www.pvaexpo.cz

Contact information:
Eldar Yunusmetov
Foreign Trade Department / Lease coordinator
T: +420 225 291 185, M: +420 739 003 158
E: yunusmetov@abf.cz

Ing. arch. Pavel Meixner
director of the PVA EXPO PRAGUE exhibition centre
T: +420 225 291 119, M: +420 739 003 131
E: meixner@abf.cz

OUR CLIENTS



PARTNER OF THE CONGRESS HALL



stonescatering
Milujeme to co děláme.

PARTNER OF THE CONGRESS HALL

MDLEXPO s.r.o.

CETIN
ČESKÁ TELEKOMUNIKAČNÍ INFRASTRUKTURA

STŘECHY PRAHA
veletrh pro stavbu a renovaci střech

